

Stackable Multi-Connector Connector

Package : 1 pc. in a bag

- Connector realizes simultaneous connections and disconnection of multiple piping.
- Connections can be stacked or combined using Connector Band.
- Multiple connection with different diameter tubings.

Specifications

Fluid admitted	Air, Vacuum	
Service pressure range	0~150psi	0~0.9MPa(0~9.18kgf/cm ²)
Working vacuum	-29.5in.Hg	-750mmHg(10Torr)
Service temperature range	32~140°F	0~60°C

Notes: Use the connector with air only. Never use them with water or other liquids, or with gases other than air.

Model Designation(Example)



①Type

②Male side tube dia.(φD)

Tube dia.	φ1/8in.	φ5/32in.	φ1/4in.	φ5/16in.	φ3mm	φ4mm	φ6mm	φ8mm
Straight	1/8	5/32	1/4	5/16	3	4	6	8
Elbow	1/8L	5/32L	1/4L	5/16L	3L	4L	6L	8L

③Female side tube Dia(φD₂)

Code	1/8	5/32	1/4	5/16	3	4	6	8
Dia.	φ1/8in.	φ5/32in.	φ1/4in.	φ5/16in.	φ3mm	φ4mm	φ6mm	φ8mm

④Type

No Code: Standard Type
M: Mini Type

Connector Band Model Designation

Series connection: QB-T
Parallel connection: QB-H

How to Connect

- After plugging the male block in to the female, turn the cam lock on the female block by a slot screwdriver or a hex key and make sure it does not come off.

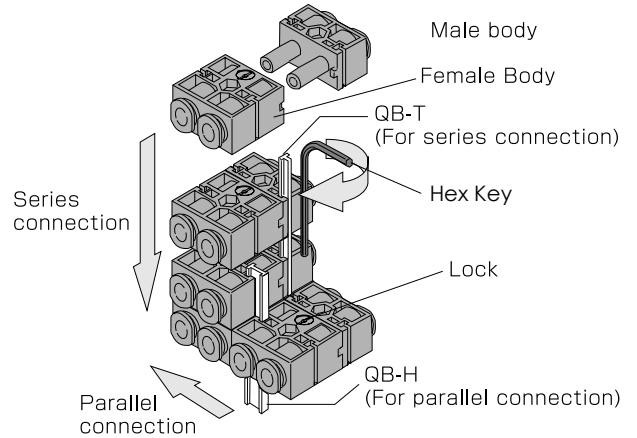

※ Standard type can not be connected with mini type

※ Maximum vertical stacking is 4 connectors.

⚠ Caution

Insert male connector fully into female connector until it stops and turn the cam lock properly to prevent from air leakage or personal injury.

Use a flathead screw driver or a hex key to turn a lock-pin. Otherwise, it may cause the separation of connectors, damage of the lock-pin or inseparable connectors.

Model Designation(Female connector unit)

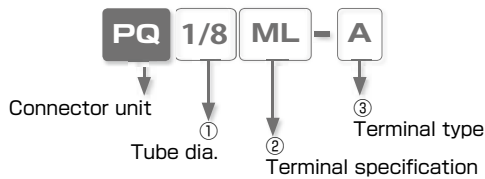

① Tube dia.

Code	1/8	5/32	1/4	5/16
Dia. (mm)	φ1/8in.	φ5/32in.	φ1/4in.	φ5/16in.

Code	3	4	6	8
Dia. (mm)	φ3mm	φ4mm	φ6mm	φ8mm

② Terminal specification

No code : Standard type (1/4", 5/16", ø6, 8mm only)

L : Standard type elbow (1/4", 5/16", ø6, 8mm male connector only)

M : Mini type (1/8", 5/32", ø3, 4, 6mm only)

ML : Mini type elbow (1/8", 5/32", ø3, 4, 6mm male connector only)

③ Terminal type

A : Male

B : Female

QB

Connector Band

QB-T : Vertical connection

QB-H: Horizontal connection

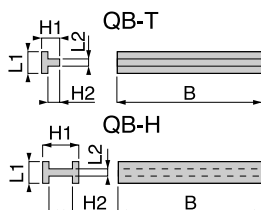

Unit : inch

Model	B	L1	L2	H	H2	Weight (OZ)
QB-T	1.89	0.12	0.04	0.10	0.06	0.02
QB-H	1.89	0.12	0.04	0.20	0.14	0.02

QC

Straight

Mini-type

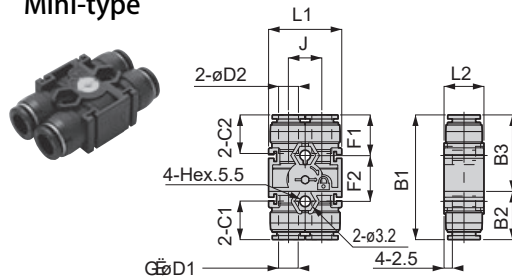

Standard type

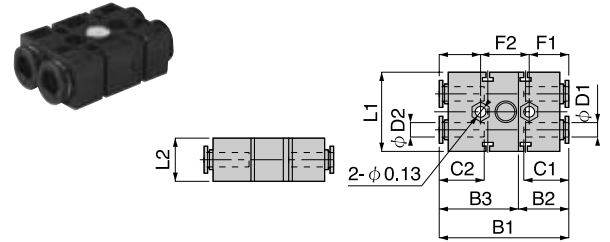

Unit : inch

Model	Tube dia. øD1 (mm)	Tube dia. øD2 (mm)	B1	B2	B3	L1	L2	C1	C2	F1	F2	Weight (OZ)	Eff.a. mm2	CV
QC3-3M	3	3	1.44	0.55	0.89	0.87	0.47	0.43	0.43	0.46	0.54	0.30	2.60	0.14
QC3-4M	3	4	1.44	0.55	0.89	0.87	0.47	0.43	0.43	0.46	0.54	0.30	2.60	0.14
QC3-6M	3	6	1.46	0.55	0.91	0.87	0.47	0.43	0.46	0.48	0.54	0.33	2.60	0.14
QC4-3M	4	3	1.44	0.55	0.89	0.87	0.47	0.43	0.43	0.46	0.54	0.30	2.60	0.14
QC4-4M	4	4	1.44	0.55	0.89	0.87	0.47	0.43	0.43	0.46	0.54	0.29	4.20	0.23
QC4-6M	4	6	1.46	0.55	0.91	0.87	0.47	0.43	0.46	0.48	0.54	0.32	4.30	0.23
QC6-3M	6	3	1.46	0.57	0.89	0.87	0.47	0.46	0.43	0.46	0.54	0.32	2.60	0.14
QC6-4M	6	4	1.46	0.57	0.89	0.87	0.47	0.46	0.43	0.46	0.54	0.31	4.20	0.23
QC6-6M	6	6	1.48	0.57	0.91	0.87	0.47	0.46	0.46	0.48	0.54	0.35	10.40	0.56
QC6-6	6	6	2.13	0.82	1.31	1.14	0.67	0.67	0.67	0.68	0.77	1.02	10.90	0.59
QC6-8	6	8	2.13	0.82	1.31	1.14	0.67	0.67	0.71	0.68	0.77	1.06	10.90	0.59
QC8-6	8	6	2.13	0.82	1.31	1.14	0.67	0.71	0.67	0.68	0.77	1.06	10.90	0.59
QC8-8	8	8	2.13	0.82	1.31	1.14	0.67	0.71	0.71	0.68	0.77	1.09	16.30	0.88

Unit : inch

Model	Tube dia. øD1	Tube dia. øD2	B1	B2	B3	L1	L2	C1	C2	F1	F2	Weight (OZ)	Eff.a. mm2	CV
QC1/8-1/8M	1/8	1/8	1.44	0.55	0.89	0.87	0.47	0.43	0.43	0.46	0.54	0.30	2.60	0.14
QC5/32-1/8M	5/32	1/8	1.44	0.55	0.89	0.87	0.47	0.43	0.43	0.46	0.54	0.30	2.60	0.14
QC1/8-5/32M	1/8	5/32	1.44	0.55	0.89	0.87	0.47	0.43	0.43	0.46	0.54	0.30	2.60	0.14
QC5/32-5/32M	5/32	5/32	1.44	0.55	0.89	0.87	0.47	0.43	0.43	0.46	0.54	0.29	4.20	0.23
QC1/4-1/4	1/4	1/4	2.25	0.88	1.37	1.14	0.67	0.67	0.67	0.74	0.77	1.55	10.90	0.59
QC5/16-5/16	5/16	5/16	2.12	0.81	1.31	1.14	0.67	0.71	0.71	0.68	0.77	1.09	16.30	0.88
QC1/4-5/16	1/4	5/16	2.19	0.88	1.22	1.14	0.67	0.67	0.71	0.68	0.77	1.34	10.90	0.59
QC5/16-1/4	5/16	1/4	2.19	0.81	1.31	1.14	0.67	0.71	0.67	0.74	0.77	1.34	10.90	0.59

QC

Elbow

Mini-type

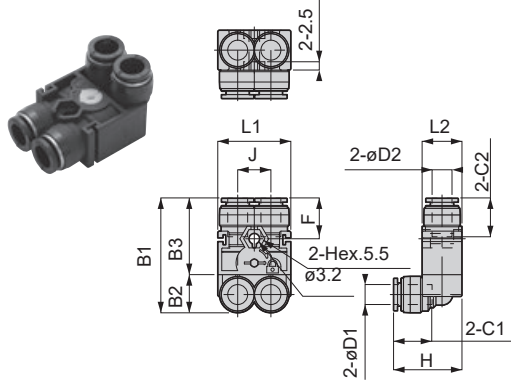

Standard type

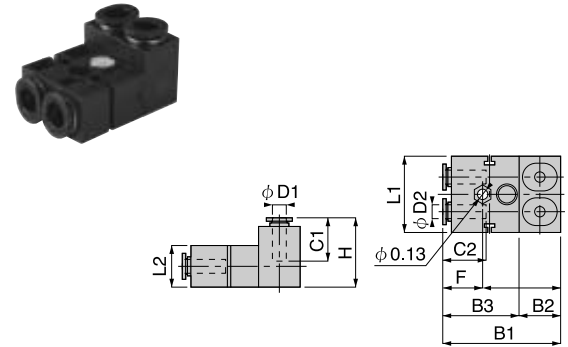

Unit : inch

Model	Tube dia. øD1	Tube dia. øD2	B1	B2	B3	L1	L2	C1	C2	H	F	Weight (OZ)	Eff.a. mm2	CV
QC1/8L-1/8M	1/8	1/8	1.30	0.41	0.89	0.87	0.47	0.43	0.43	0.80	0.46	0.32	2.30	0.12
QC5/32L-1/8M	5/32	1/8	1.30	0.41	0.89	0.87	0.47	0.43	0.43	0.80	0.46	0.32	2.60	0.14
QC1/8L-5/32M	1/8	5/32	1.30	0.41	0.89	0.87	0.47	0.43	0.43	0.80	0.46	0.32	2.60	0.14
QC5/32L-5/32M	5/32	5/32	1.30	0.41	0.89	0.87	0.47	0.43	0.43	0.80	0.46	0.31	4.00	0.22
QC1/4L-1/4	1/4	1/4	2.04	0.67	1.37	1.14	0.67	0.67	0.67	1.26	0.74	1.62	9.50	0.51
QC5/16L-5/16	5/16	5/16	1.98	0.67	1.31	1.14	0.67	0.71	0.71	1.19	0.68	1.16	13.30	0.72
QC1/4L-5/16	1/4	5/16	1.98	0.67	1.31	1.14	0.67	0.67	0.71	1.26	0.68	1.41	10.90	0.59
QC5/16L-1/4	5/16	1/4	2.04	0.67	1.37	1.14	0.67	0.71	0.67	1.19	0.74	1.41	10.90	0.59

Unit : inch

Model	Tube dia. øD1 (mm)	Tube dia. øD2 (mm)	B1	B2	B3	L1	L2	C1	C2	H	F	Weight (OZ)	Eff.a. mm2	CV
QC3L-3M	3	3	1.30	0.41	0.89	0.87	0.47	0.43	0.43	0.80	0.46	0.32	2.30	0.12
QC3L-4M	3	4	1.30	0.41	0.89	0.87	0.47	0.43	0.43	0.80	0.46	0.32	2.60	0.14
QC3L-6M	3	6	1.31	0.41	0.91	0.87	0.47	0.43	0.46	0.80	0.48	0.35	2.60	0.14
QC4L-3M	4	3	1.30	0.41	0.89	0.87	0.47	0.43	0.43	0.80	0.46	0.32	2.60	0.14
QC4L-4M	4	4	1.30	0.41	0.89	0.87	0.47	0.43	0.43	0.80	0.46	0.31	4.00	0.22
QC4L-6M	4	6	1.31	0.41	0.91	0.87	0.47	0.43	0.46	0.80	0.48	0.35	4.20	0.23
QC6L-3M	6	3	1.34	0.45	0.89	0.87	0.47	0.46	0.43	0.81	0.46	0.35	2.60	0.14
QC6L-4M	6	4	1.34	0.45	0.89	0.87	0.47	0.46	0.43	0.81	0.46	0.34	4.20	0.23
QC6L-6M	6	6	1.36	0.45	0.91	0.87	0.47	0.46	0.46	0.81	0.48	0.39	8.80	0.48
QC6L-6	6	6	1.98	0.67	1.32	1.14	0.67	0.67	0.67	1.19	0.68	1.09	9.50	0.51
QC6L-8	6	8	1.98	0.67	1.32	1.14	0.67	0.67	0.71	1.19	0.68	1.13	9.90	0.54
QC8L-6	8	6	1.98	0.67	1.32	1.14	0.67	0.71	0.67	1.19	0.68	1.13	10.90	0.59
QC8L-8	8	8	1.98	0.67	1.32	1.14	0.67	0.71	0.71	1.19	0.68	1.16	13.30	0.72

Male / Female Terminal Alone

PQ

Straight Male Terminal Only

Mini-type

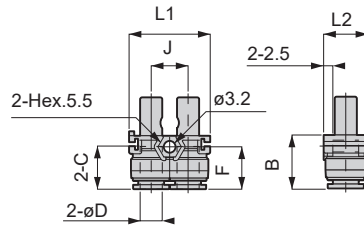

Standard type

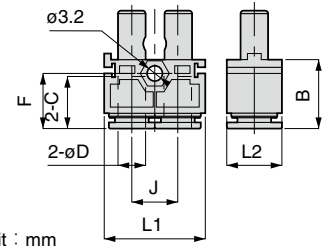

Unit : mm

Model code	Tube O.D. øD	B	L1	L2	Tube end C	J	F	Weight (g)	CAD file name
PQ1/8M-A	1/8	14.1	22	12	11	10	11.1	3.8	PQ1_8M-A
PQ5/32M-A	5/32	14.1	22	12	11	10	11.1	3.6	PQ5_32M-A
PQ1/4-A	1/4	22.4	29	17	17	14	18.9	21	PQ1_4-A
PQ5/16-A	5/16	20.7	29	17	18.1	14	17.2	14	PQ5_16-A
PQ3M-A	3	14.1	22	12	11	10	11.1	3.8	PQ3M-A
PQ4M-A	4	14.1	22	12	11	10	11.1	3.6	PQ4M-A
PQ6M-A	6	14.5	22	12	11.6	10	11.5	4.3	PQ6M-A
PQ6-A	6	20.8	29	17	17	14	17.3	13	PQ6-A
PQ8-A	8	20.7	29	17	18.1	14	17.2	14	PQ8-A

PQ

Elbow Male Terminal Only

Mini-type

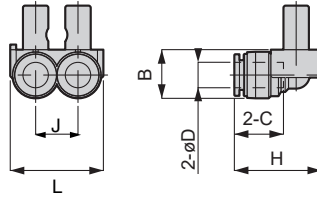

Standard type

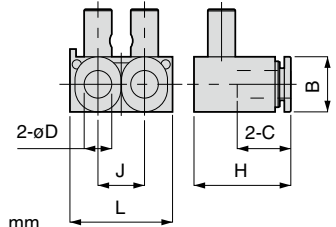

Unit : mm

Model code	Tube O.D. øD	B	L	H	Tube end C	J	Weight (g)	CAD file name
PQ1/8ML-A	1/8	10.3	22	20.2	11	10	4.4	PQ1_8ML-A
PQ5/32ML-A	5/32	10.3	22	20.2	11	10	4.2	PQ5_32ML-A
PQ1/4L-A	1/4	17	29	20.6	17	14	23	PQ1_4L-A
PQ5/16L-A	5/16	17	29	30.2	18.1	14	16	PQ5_16L-A
PQ3ML-A	3	10.3	22	20.2	11	10	4.4	PQ3ML-A
PQ4ML-A	4	10.3	22	20.2	11	10	4.2	PQ4ML-A
PQ6ML-A	6	11.5	22	20.6	11.6	10	5	PQ6ML-A
PQ6L-A	6	17	29	30.3	17	14	15	PQ6L-A
PQ8L-A	8	17	29	30.2	18.1	14	16	PQ8L-A

PQ

Female Terminal Only

Mini-type

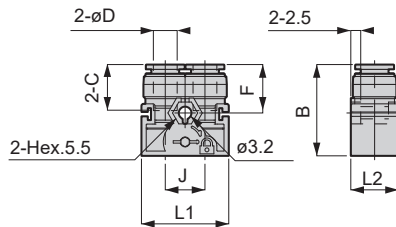

Standard type

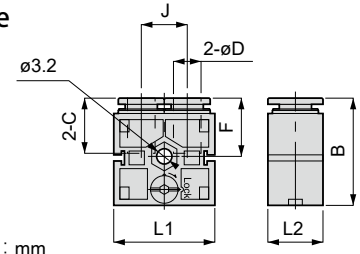

Unit : mm

Model code	Tube O.D. øD	B	L1	L2	Tube end C	J	F	Weight (g)	CAD file name
PQ1/8M-B	1/8	22.6	22	12	11	10	11.8	4.8	PQ1_8M-B
PQ5/32M-B	5/32	22.6	22	12	11	10	11.8	4.6	PQ5_32M-B
PQ1/4-B	1/4	34.9	29	17	17	14	18.9	24	PQ1_4-B
PQ5/16-B	5/16	33.2	29	17	18.1	14	17.2	17	PQ5_16-B
PQ3M-B	3	22.6	22	12	11	10	11.8	4.8	PQ3M-B
PQ4M-B	4	22.6	22	12	11	10	11.8	4.6	PQ4M-B
PQ6M-B	6	23	22	12	11.6	10	12.2	5.6	PQ6M-B
PQ6-B	6	33.3	29	17	17	14	17.3	16	PQ6-B
PQ8-B	8	33.2	29	17	18.1	14	17.2	17	PQ8-B

Body shape comparison

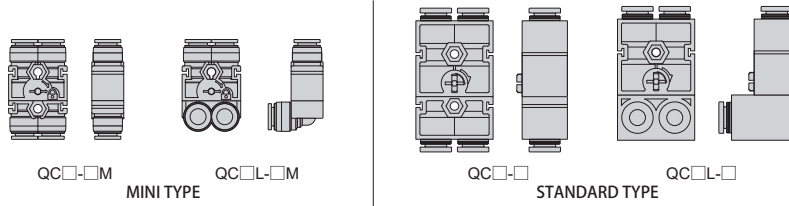

Standard Size List

Male / Female connector set

Type	Male terminal tube O.D.	Female terminal tube O.D.							
		1/8	5/32	1/4	5/16	3	4	6	8
QC Straight	1/8	●	●			●	●	●	
	5/32	●	●						
	1/4			●	●			●	●
	5/16			●	●				
	3		●			●	●	●	
	4	●	●			●	●	●	
	6	●		●		●	●	●	●
	8							●	●

Type	Male terminal tube O.D.	Female terminal tube O.D.							
		1/8	5/32	1/4	5/16	3	4	6	8
QC Elbow	1/8	●	●			●	●	●	
	5/32	●	●						
	1/4			●	●			●	●
	5/16			●	●				
	3		●			●	●	●	
	4	●	●			●	●	●	
	6	●		●		●	●	●	●
	8							●	●

Male connector unit

Type	Tube O.D.							
	1/8	5/32	1/4	5/16	3	4	6	8
PQ-A Straight Male Only	●	●	●	●	●	●	●	●

Type	Tube O.D.							
	1/8	5/32	1/4	5/16	3	4	6	8
PQ-A Elbow Male Only	●	●	●	●	●	●	●	●

Female connector unit

Type	Tube O.D.							
	1/8	5/32	1/4	5/16	3	4	6	8
PQ-B Female Only	●	●	●	●	●	●	●	●

How to connect and disconnect

1. How to connect and disconnect tubes

① Tube insertion

Push in a tubing up to the very end. Lock-claws bite the tubing and hold it automatically while the elastic sleeve seals around the tubing.

Refer to "2. Instructions for Tube Insertion" under "Common Safety Instructions for Fittings" .

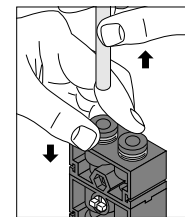
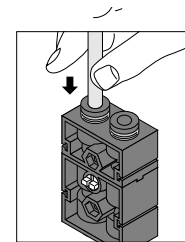

② Tube disconnection

The tubing is pulled out by pushing the release-ring which opens the Lock-claws.

Make sure turning off the air supply before the tubing disconnection.

2. How to couple and uncouple connectors

① Coupling connectors

After coupling a male connector and a female connector, use a flathead screwdriver or a hex key to turn lock-pin by 90 degrees in the clockwise direction to lock them.

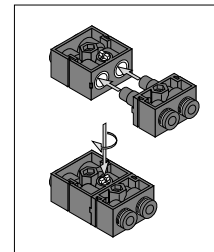

② Uncoupling connectors

Use a flathead screwdriver or a hex key to turn lock-pin by 90 degrees in the counterclockwise direction to uncouple them.

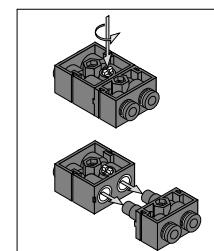

Detailed Safety Instructions

Before using PISCO products, be sure to read “Safety Instructions” and “Safety Instruction Manual” and “Common Safety Instructions for Fittings”.

Caution

1. Avoid radial load. It may reduce the lifetime of the products.
2. Use polyurethane tube for the high rotation applications. Hard tubes like nylon base may cause radial load to the fitting.

Disclaimer

1. PISCO does not take any responsibility for any incidental or indirect loss, such as production line stop, interruption of business, loss of benefits, personal injury, etc., caused by any failure on use or application of PISCO products.
2. PISCO does not take any responsibility for any loss caused by natural disasters, fires not related to PISCO products, acts by third parties, and intentional or accidental damages of PISCO products due to incorrect usage.
3. PISCO does not take any responsibility for any loss caused by improper usage of PISCO products such as exceeding the specification limit or not following the usage the published instructions and catalog allow.
4. PISCO does not take any responsibility for any loss caused by remodeling of PISCO products, or by combinational use with non-PISCO products and other software systems.
5. The damages caused by the defect of Pisco products shall be covered but limited to the full amount of the PISCO products paid by the customer.

SAFETY Instructions

This safety instructions aim to prevent personal injury and damage to properties by requiring proper use of PISCO products. Be certain to follow ISO 4414 and JIS B 8370

ISO 4414 : Pneumatic fluid power...Recommendations for the application of equipment to transmission and control systems.

JIS B 8370 : General rules and safety requirements for systems and their components.

This safety instructions is classified into “Danger”, “Warning” and “Caution” depending on the degree of danger or damages caused by improper use of PISCO products.

 **Danger** Hazardous conditions. It can cause death or serious personal injury.

 **Warning** Hazardous conditions depending on usages. Improper use of PISCO products can cause death or serious personal injury.

 **Caution** Hazardous conditions depending on usages. Improper use of PISCO products can cause personal injury or damages to properties.

Warning

1. Selection of pneumatic products
 - ① A user who is a pneumatic system designer or has sufficient experience and technical expertise should select PISCO products.
 - ② Due to wide variety of operating conditions and applications for PISCO products, carry out the analysis and evaluation on PISCO products. The pneumatic system designer is solely responsible for assuring that the user's requirements are met and that the application presents no health or safety hazards. All designers are required to fully understand the specifications of PISCO products and constitute all systems based on the latest catalog or information, considering any malfunctions.
2. Handle the pneumatic equipment with enough knowledge and experience
 - ① Improper use of compressed air is dangerous. Assembly, operation and maintenance of machines using pneumatic equipment should be conducted by a person with enough knowledge and experience.
3. Do not operate machine / equipment or remove pneumatic equipment until safety is confirmed.
 - ① Make sure that preventive measures against falling work-pieces or sudden movements of machine are completed before inspection or maintenance of these machine.
 - ② Make sure the above preventive measures are completed. A compressed air supply and the power supply to the machine must be off, and also the compressed air in the systems must be exhausted.
 - ③ Restart the machines with care after ensuring to take all preventive measures against sudden movements.

※ . This safety instructions are subject to change without notice.



SAFETY INSTRUCTION MANUAL

PISCO products are designed and manufactured for use in general industrial machines. Be sure to read and follow the instructions below.

Danger

1. Do not use PISCO products for the following applications.
 - ① Equipment used for maintaining / handling human life and body.
 - ② Equipment used for moving / transporting human.
 - ③ Equipment specifically used for safety purposes.

Warning

1. Do not use PISCO products under the following conditions.
 - ① Beyond the specifications or conditions stated in the catalog, or the instructions.
 - ② Under the direct sunlight or outdoors.
 - ③ Excessive vibrations and impacts.
 - ④ Exposure / adhere to corrosive gas, inflammable gas, chemicals, seawater, water and vapor. ** Some products can be used under the condition above(④), refer to the details of specification and condition of each product.
2. Do not disassemble or modify PISCO products, which affect the performance, function, and basic structure of the product.
3. Turn off the power supply, stop the air supply to PISCO products, and make sure there is no residual air pressure in the pipes before maintenance and inspection.
4. Do not touch the release-ring of push-in fitting when there is a working pressure. The lock may be released by the physical contact, and tube may fly out or slip out.
5. Frequent switchover of compressed air may generate heat, and there is a risk of causing burn injury.
6. Avoid any load on PISCO products, such as a tensile strength, twisting and bending. Otherwise, there is a risk of causing damage to the products.
7. As for applications where threads or tubes swing / rotate, use Rotary Joints, High Rotary Joints or Multi-Circuit Rotary Block only. The other PISCO products can be damaged in these applications.
8. Use only Die Temperature Control Fitting Series, Tube Fitting Stainless SUS316 Series, Tube Fitting Stainless SUS316 Compression Fitting Series or Tube Fitting Brass Series under the condition of over 60°C (140° F) water or thermal oil. Other PISCO products can be damaged by heat and hydrolysis under the condition above.
9. As for the condition required to dissipate static electricity or provide an antistatic performance, use EG series fitting and antistatic products only, and do not use other PISCO products. There is a risk that static electricity can cause system defects or failures.
10. Use only Fittings with a characteristic of spatter-proof such as Anti-spatter or Brass series in a place where flame and weld spatter is produced. There is a risk of causing fire by sparks.
11. Turn off the power supply to PISCO products, and make sure there is no residual air pressure in the pipes and equipment before maintenance. Follow the instructions below in order to ensure safety.
 - ① Make sure the safety of all systems related to PISCO products before maintenance.
 - ② Restart of operation after maintenance shall be proceeded with care after ensuring safety of the system by preventive measures against unexpected movements of machines and devices where pneumatic equipment is used.
 - ③ Keep enough space for maintenance when designing a circuit.
12. Take safety measures such as providing a protection cover if there is a risk of causing damages or fires on machine / facilities by a fluid leakage.

⚠ Caution

1. Remove dusts or drain before piping. They may get into the peripheral machine / facilities and cause malfunction.
2. When inserting an ultra-soft tube into push-in fitting, make sure to place an Insert Ring into the tube edge. There is a risk of causing the escape of tube and a fluid leakage without using an Insert Ring.
3. The product incorporating NBR as seal rubber material has a risk of malfunction caused by ozone crack. Ozone exists in high concentrations in static elimination air, clean-room, and near the high-voltage motors, etc. As a countermeasure, material change from NBR to HNBR or FKM is necessary. Consult with PISCO for more information.
4. Special option "Oil-free" products may cause a very small amount of a fluid leakage. When a fluid medium is liquid or the products are required to be used in harsh environments, contact us for further information.
5. In case of using non-PISCO brand tubes, make sure the tolerance of the outer tube diameter is within the limits of Table 1.

● Table 1. Tube O.D. Tolerance

mm size	Nylon tube	Polyurethane tube	inch size	Nylon tube	Polyurethane tube
ø1.8mm	—	± 0.05mm	ø1/8	± 0.1mm	± 0.15mm
ø3mm	—	± 0.15mm	ø5/32	± 0.1mm	± 0.15mm
ø4mm	± 0.1mm	± 0.15mm	ø3/16	± 0.1mm	± 0.15mm
ø6mm	± 0.1mm	± 0.15mm	ø1/4	± 0.1mm	± 0.15mm
ø8mm	± 0.1mm	± 0.15mm	ø5/16	± 0.1mm	± 0.15mm
ø10mm	± 0.1mm	± 0.15mm	ø3/8	± 0.1mm	± 0.15mm
ø12mm	± 0.1mm	± 0.15mm	ø1/2	± 0.1mm	± 0.15mm
ø16mm	± 0.1mm	± 0.15mm	ø5/8	± 0.1mm	± 0.15mm

6. Instructions for Tube Insertion

- ① Make sure that the cut end surface of the tube is at right angle without a scratch on the surface and deformations.
- ② When inserting a tube, the tube needs to be inserted fully into the push-in fitting until the tubing edge touches the tube end of the fitting as shown in the figure below. Otherwise, there is a risk of leakage.

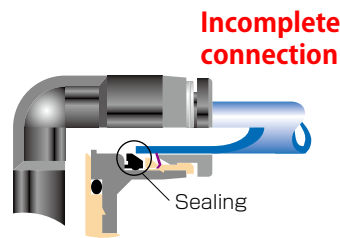
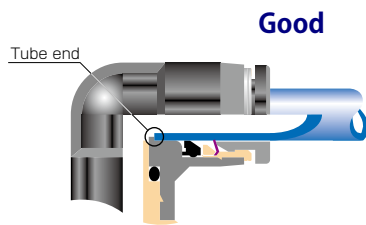

Tube is not fully inserted up to tube end.

- ③ After inserting the tube, make sure it is inserted properly and not to be disconnected by pulling it moderately.
- ※ . When inserting tubes, Lock-claws may be hardly visible in the hole, observed from the front face of the release-ring. But it does not mean the tube will surely escape. Major causes of the tube escape are the followings:
- ① Shear drop of the lock-claws edge
 - ② The problem of tube diameter (usually small)
- Therefore, follow the above instructions from ① to ③, even lock-claws is hardly visible.

7. Instructions for Tube Disconnection

- ① Make sure there is no air pressure inside of the tube, before disconnecting it.
- ② Push the release-ring of the push-in fitting evenly and deeply enough to pull out the tube toward oneself. By insufficient pushing of the release-ring, the tube may not be pulled out or damaged by scratch, and tube shavings may remain inside of the fitting, which may cause the leakage later.

8. Instructions for Installing a fitting

- ① When installing a fitting, use proper tools to tighten a hexagonal-column or an inner hexagonal socket. When inserting a hex key into the inner hexagonal socket of the fitting, be careful so that the tool does not touch lock-claws. The deformation of lock-claws may result in a poor performance of systems or an escape of the tube.
- ② Refer to Table 2 which shows the recommended tightening torque. Do not exceed these limits to tighten a thread. Excessive tightening may break the thread part or deform the gasket and cause a fluid leakage. Tightening thread with tightening torque lower than these limits may cause a loosened thread or a fluid leakage.
- ③ Adjust the tube direction while tightening thread within these limits, since some PISCO products are not rotatable after the installation.

● Table 2: Recommended tightening torque / Sealock color / Gasket materials

Thread type	Thread size	Tightening torque	Sealock color	Gasket materials
Metric thread	M3 × 0.5	0.7N·m	—	SUS304 NBR
	M5 × 0.8	1.0 ~ 1.5N·m		
	M6 × 1	2 ~ 2.7N·m		
	M3 × 0.5	0.5 ~ 0.6N·m		POM
	M5 × 0.8	1 ~ 1.5N·m		
	M6 × 0.75	0.8 ~ 1N·m		
Taper pipe thread	M8 × 0.75	1 ~ 2N·m	White	—
	R1/8	7 ~ 9N·m		
	R1/4	12 ~ 14N·m		
	R3/8	22 ~ 24N·m		
Unified thread	R1/2	28 ~ 30N·m	—	SUS304, NBR
	No.10-32UNF	1.0 ~ 1.5N·m		
National pipe thread taper	1/16-27NPT	7 ~ 9N·m	White	—
	1/8-27NPT	7 ~ 9N·m		
	1/4-18NPT	12 ~ 14N·m		
	3/8-18NPT	22 ~ 24N·m		
	1/2-14NPT	28 ~ 30N·m		

※ These values may differ for some products. Refer to each specification as well.

9. Instructions for removing a fitting

- ① When removing a fitting, use proper tools to loosen a hexagonal-column or an inner hex bolt.
- ② Remove the sealant stuck on the mating equipment. The remained sealant may get into the peripheral equipment and cause malfunctions.

10. Arrange piping avoiding any load on fittings and tubes such as twist, tensile, moment load, shaking and physical impact. These may cause damages to fittings, tube deformations, bursting and the escape of tubes.

Common Safety Instructions for Fittings

Before selecting or using PISCO products, read the following instructions. Read the detailed instructions for individual series as well as the instructions below.

Warning

1. Do not use fittings with fluid medium other than air or water. (Water can be used with some series.) Contact us for using other kind of fluid medium except air and water.
2. Do not use fittings except Anti-spatter, Brass and Brass Compression Fitting series in a place where the flame and weld spatter is produced. There is a risk of causing fire by sparks.
3. As for applications where threads or tubes swing / rotate, use Rotary Joints, High Rotary Joints or Multi-Circuit Rotary Block only. The other PISCO products can be damaged in these applications.
4. Use only Die Temperature Control Fitting Series, Tube Fitting Stainless SUS316 Series, Tube Fitting Stainless SUS316 Compression Fitting Series or Tube Fitting Brass Series under the condition of over 60°C (140° F) water or thermal oil. Other PISCO products can be damaged by heat and hydrolysis under the condition above.
5. As for the condition required to dissipate static electricity or provide an antistatic performance, use EG Series fitting and antistatic products only, and do not use other PISCO products. There is a risk that static electricity can cause system defects or failures.
6. Avoid any load on PISCO products, such as a tensile strength, twisting and bending. Otherwise, there is a risk of causing damage to the products.